



## Introduction

The OMRON RX3 Plus measures your blood pressure and pulse simply and quickly from the wrist, without the use of an inflation bulb or stethoscope. The measurement values are stored in the memory of the OMRON RX3 Plus. The OMRON RX3 Plus fits wrist circumferences from 13.5 to 19.5 cm.

# Digital Automatic Blood Pressure Monitor



## Table of contents

<b>1</b>	<b>How to obtain meaningful blood pressure readings</b>	<b>3</b>
<b>2</b>	<b>Overview</b>	<b>4</b>
<b>3</b>	<b>Preparation</b>	<b>5</b>
3.1	Insert batteries	5
3.2	Fit wrist cuff	6
<b>4</b>	<b>Operation</b>	<b>7</b>
4.1	Control functions	7
4.2	Set date and time	8
4.3	Measurement	9
4.4	Read display	10
<b>5</b>	<b>Memory</b>	<b>11</b>
5.1	Recall average value	11
5.2	Recall previous values	11
5.3	Erase memory	12
<b>6</b>	<b>Storage</b>	<b>13</b>
<b>7</b>	<b>Faults: causes and rectifications</b>	<b>13</b>
<b>8</b>	<b>Maintenance and spare parts</b>	<b>14</b>
<b>9</b>	<b>Technical data</b>	<b>15</b>
<b>10</b>	<b>General information about blood pressure</b>	<b>16</b>

## 1 How to obtain meaningful blood pressure readings

### General

- The OMRON RX3 Plus is not suitable for measuring the frequency of cardiac pacemakers.
- Consult your doctor during pregnancy, arrhythmia and arteriosclerosis.
- Avoid eating, drinking (alcohol), smoking, sport and taking a bath before measurement.
- Be calm and relaxed before and during measurement.
- You should never change the dose of medicines prescribed by your doctor.

### Tips for use

- Check your blood pressure at least twice a day (before breakfast, after work).
- Do not measure your blood pressure while you are in a vehicle.
- Always measure on the same wrist, prefer your left wrist for a comfortable use.
- Wrap the wrist cuff around your wrist before start of measurement.

### Caution

- Operating temperature between 10°C and 40°C.
- Operating environment must be free from excessive vibrations, shocks, magnetic fields, electrical noise, etc.
- Stay out of sunlight during measuring.
- Keep portable phones 5 meters away during measurement.
- Do not wrap the cuff other than around your wrist.
- Do not drop the OMRON RX3 Plus.

## 2 Overview

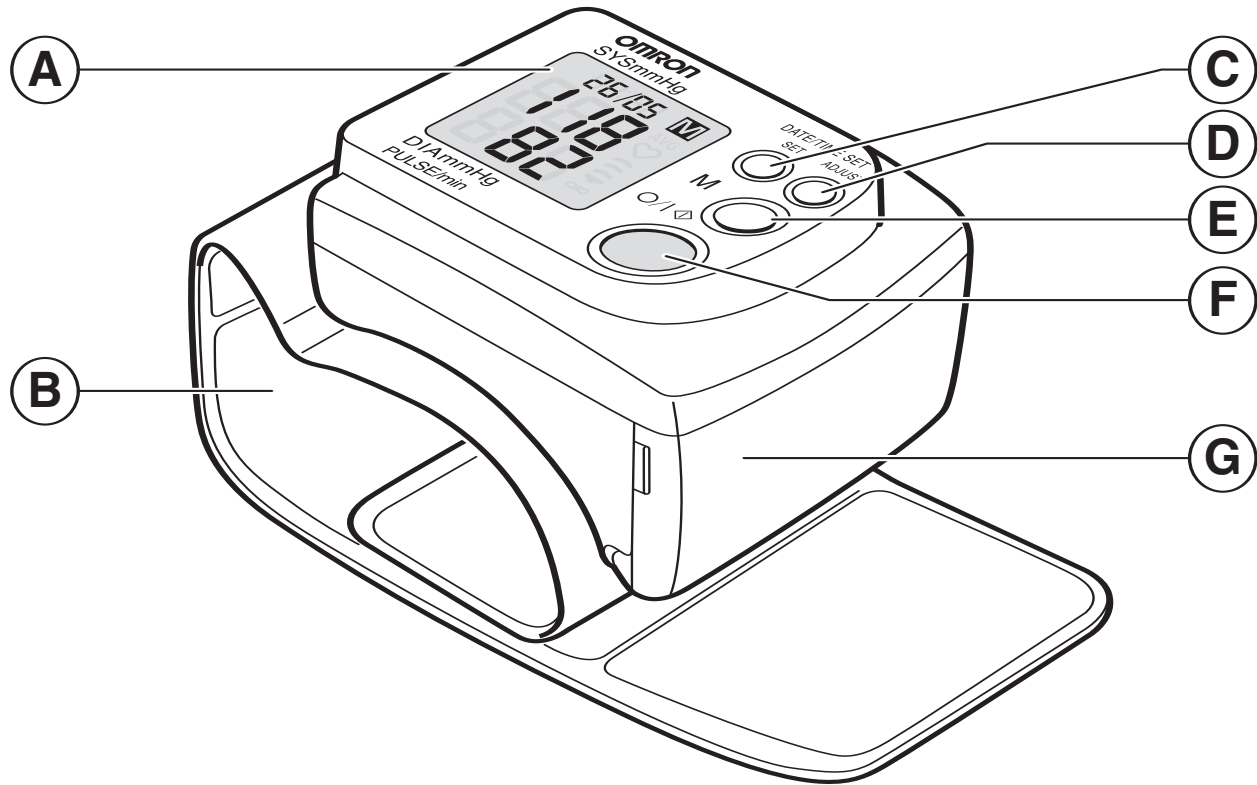

- A** Display
- B** Wrist Cuff
- C** Set button
- D** Adjust button

- E** Memory button
- F** On/off button
- G** Battery Compartment

## 3 Preparation

### 3.1 Insert batteries

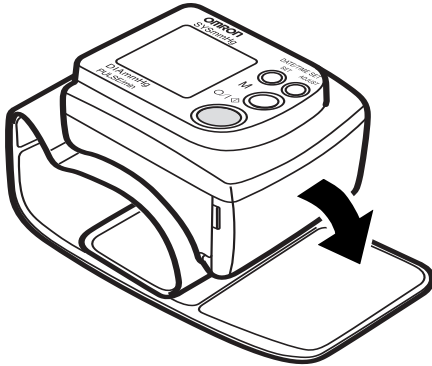

1 Open the battery compartment.

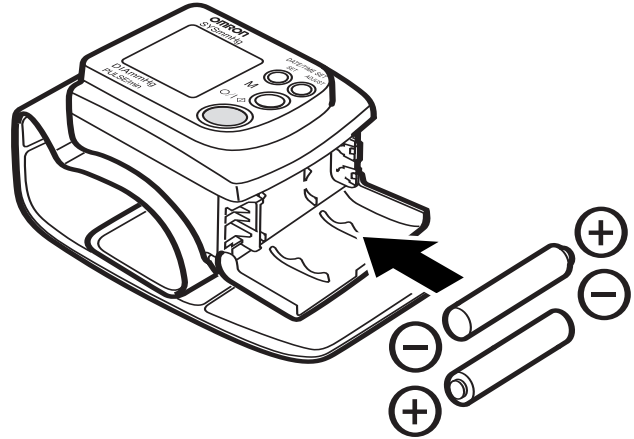

2 Insert two batteries in the battery compartment.

**Caution!** Use two identical 1.5V alkaline batteries type AAA!

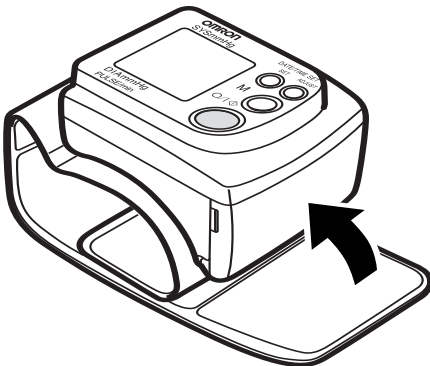

3 Close the battery compartment.

### 3.2 Fit wrist cuff

**Caution!** Do not press on/off button when the wrist cuff is not wrapped around the wrist!

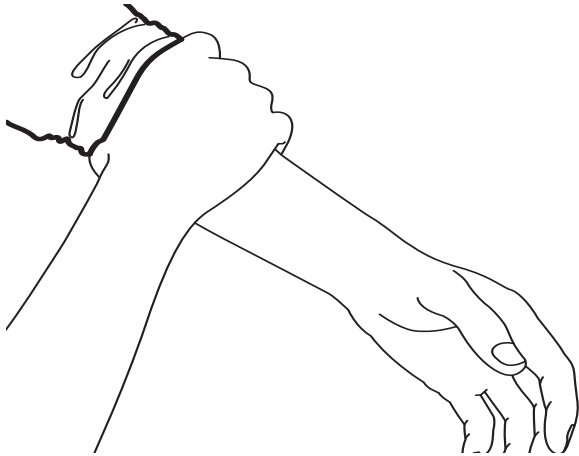

**1** Bare your wrist.

**Caution!** Push up your sleeve: avoid constricting the blood flow!

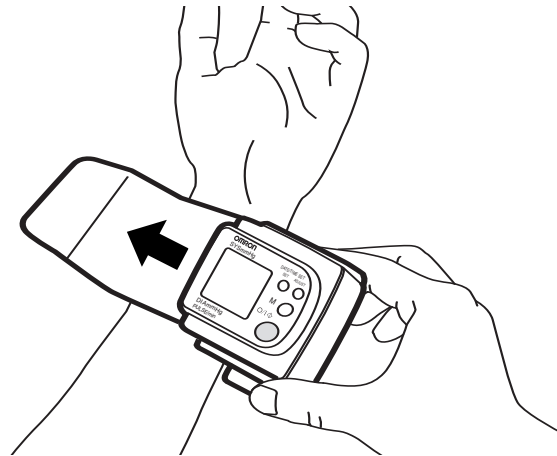

**2** Put the monitor on the inner side of your wrist.

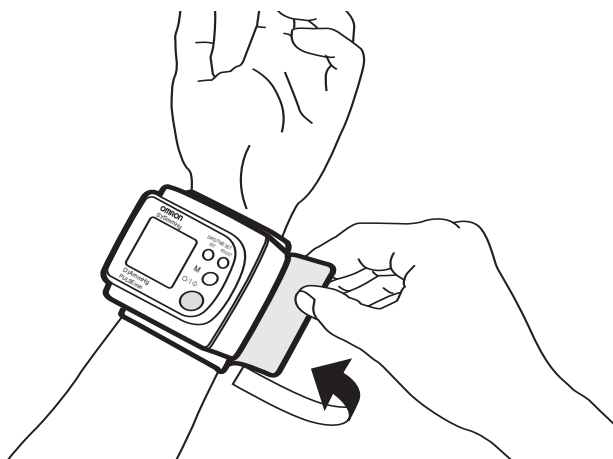

**3** Hold the end of the wrist cuff and wrap it around your wrist.

**Caution!** Be sure the wrist cuff fits closely; do not pinch your arm!

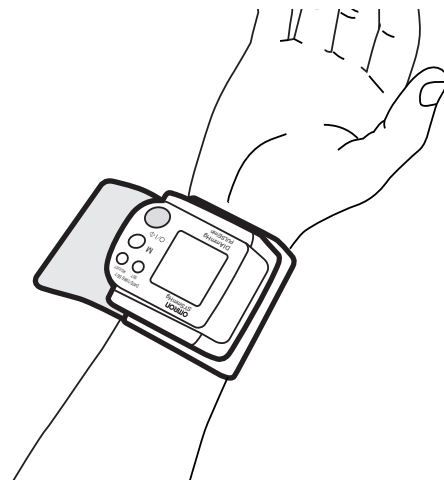

**Note:** attach the monitor upside down for reliable measurement at your right wrist.

## 4 Operation

### 4.1 Control functions

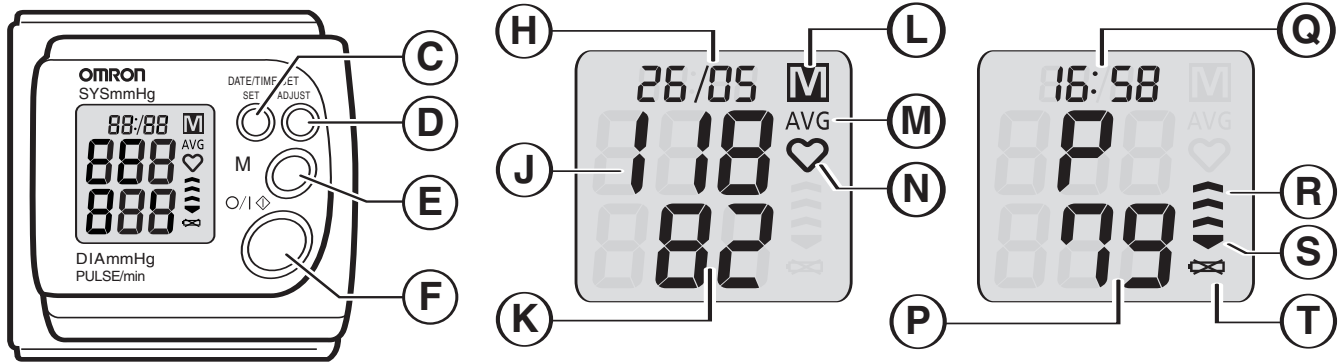

**C** Set button

**D** Adjust button

**E** Memory button

**F** On/off button

**H** Date.

**J** Systolic blood pressure in mmHg.

**K** Diastolic blood pressure in mmHg.

**L** Memory display: 21 values in memory.

**M** Average value of the latest 3 measurements displayed.

**N** Monitor blood pressure: flash - measurement takes place, light up - finish measurement.

**P** Pulse: heartbeats per minute.

**Q** Time.

**R** Inflation: wrist cuff inflates and measurement starts.

**S** Deflation: wrist cuff deflates and measurement finishes.

**T** Battery exhausted: batteries are weak/exhausted.



## 4.2 Set date and time

**Note:** each time you press adjust button year (2001-2030), month (1-12), day (1-31), hour (0-23) and minutes (0-59) advance by one unit. Keep button pressed to advance fast.

**Note:** use the grey coloured button to carry out the instruction.

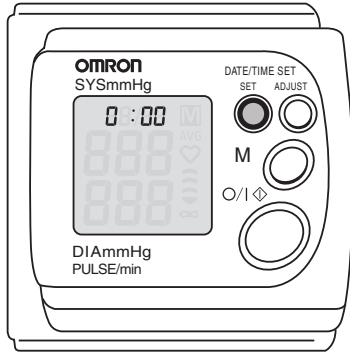

**1** Press set or adjust button.

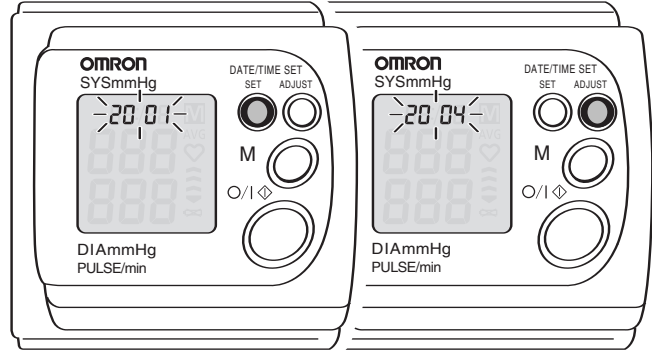

**2** Press set button for 2 seconds. Press adjust button to set the current year.

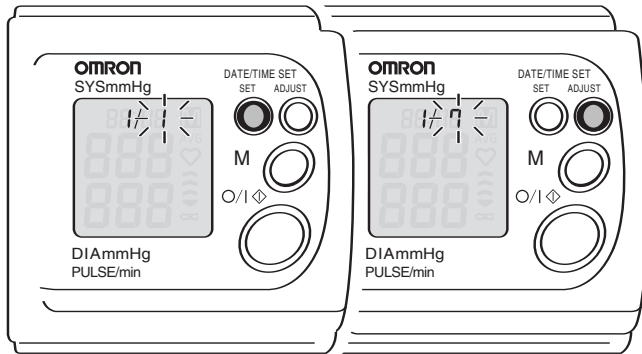

**3** Press set button to proceed to month setting. Press adjust button to set the current month.

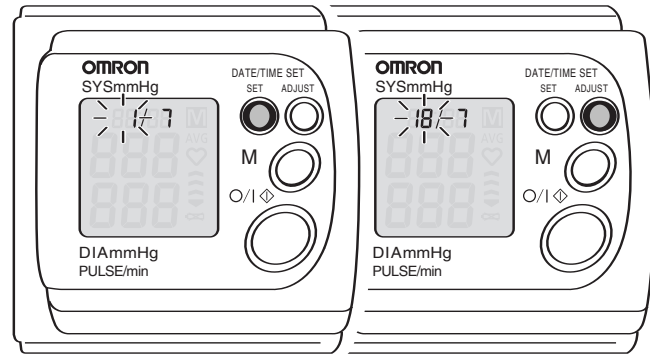

**4** Press set button to proceed to day setting. Press adjust button to set the current day.

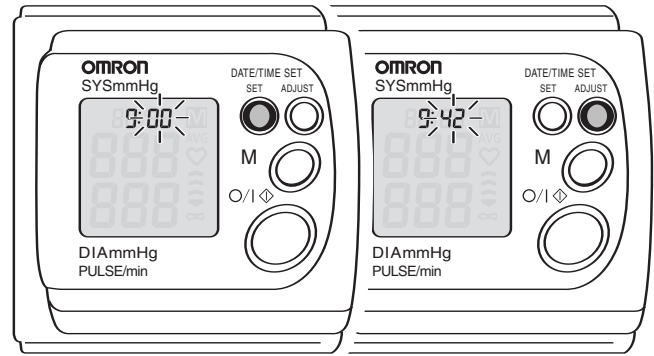
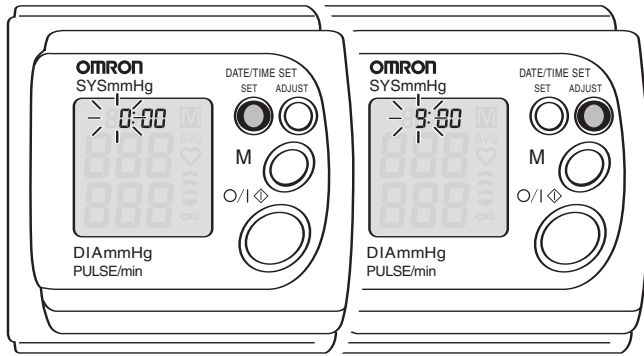

**5** Press set button to proceed to hour setting.  
Press adjust button to set the current hour.

**6** Press set button to proceed to minute setting and press adjust button to set the current minutes.

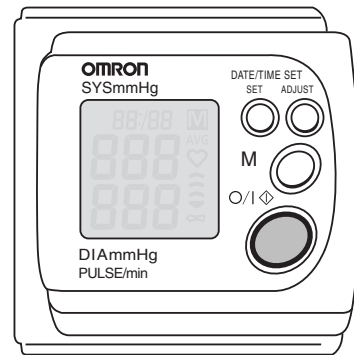
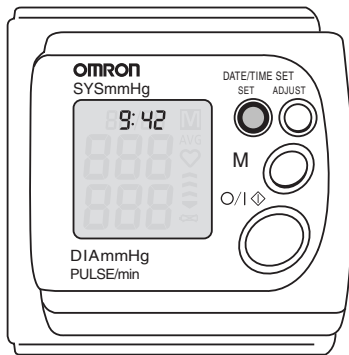

**7** Press set button to complete setting.

**8** Press on/off button.

### 4.3 Measurement

**Caution!** Allow an interval of at least three minutes between two successive measurements!

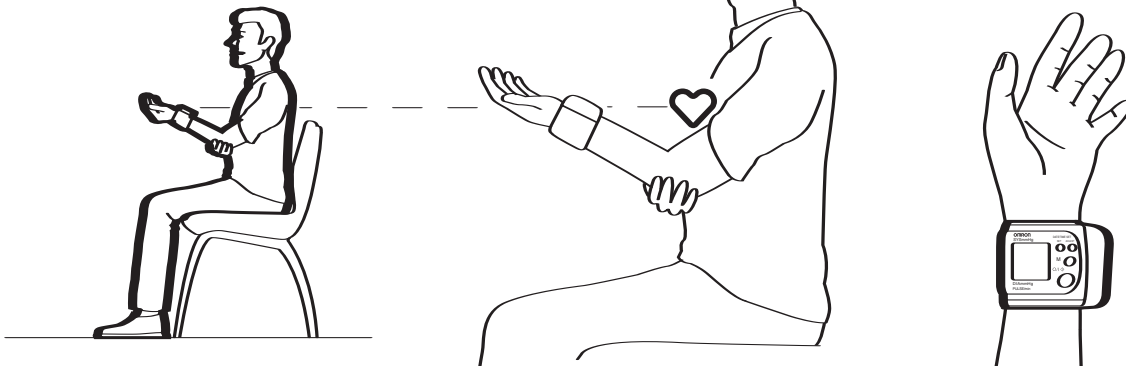

**1** Sit comfortably upright with your feet flat on the floor.

**Caution!** The OMRON RX3 Plus should always be at heart height during measurement!

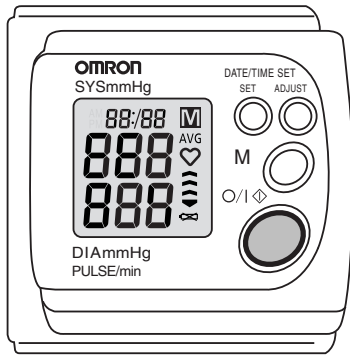

**2** Press on/off button to start measurement.

The OMRON RX3 Plus measures during inflation!

**Caution!** Sit still, do not move, do not speak and do not touch the OMRON RX3 Plus!

### 4.4 Read display

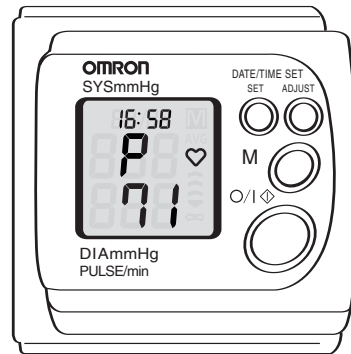
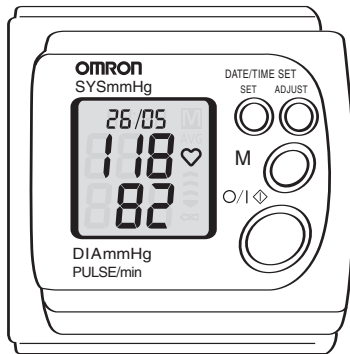

**1** Read the values of blood pressure and pulse from the display.

**Note:** display shows alternately date, blood pressures and time, heartbeats.

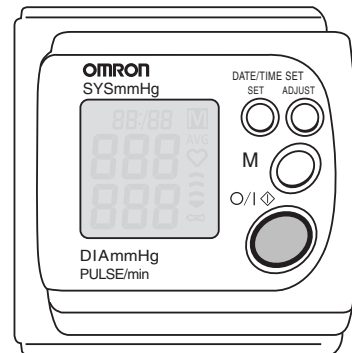
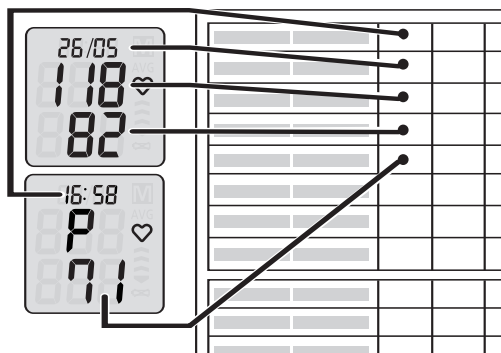

**2** Note date, time and values in your personal blood pressure pass.

**3** Press on/off button to turn off power.

## 5 Memory

### 5.1 Recall average value

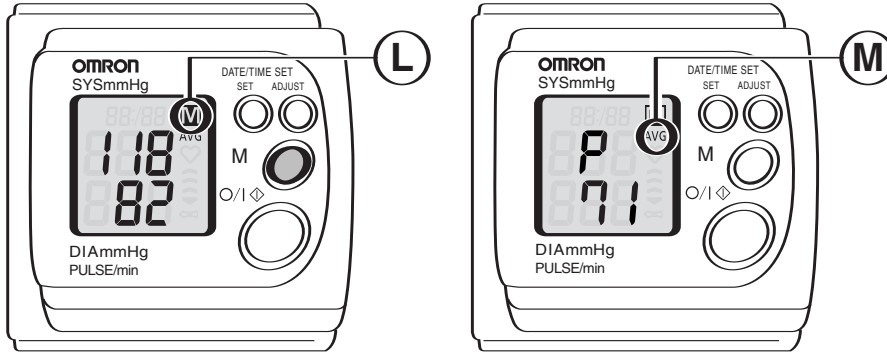

**L** Memory display: 21 values in memory.

**M** Average value of the latest 3 measurements displayed.

1 Press memory button.

**Note:** display shows alternately blood pressures and heartbeats.

### 5.2 Recall previous values

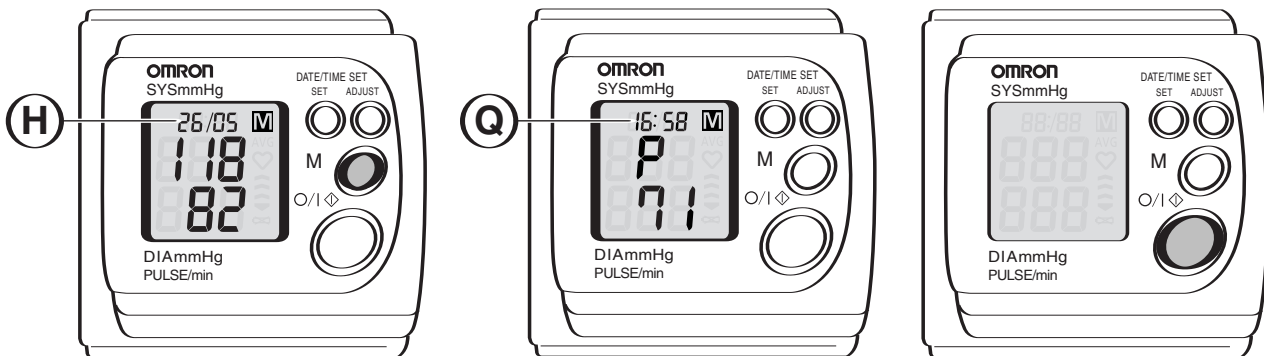

**H/Q** Date/time of measurement.

1 Press memory button for latest and previous values.

Press on/off button to turn off power.

**Note:** display shows alternately date, blood pressures and time, heartbeats.

### 5.3 Erase memory

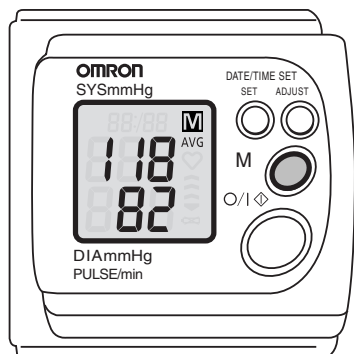

1 Press memory button to turn on power.

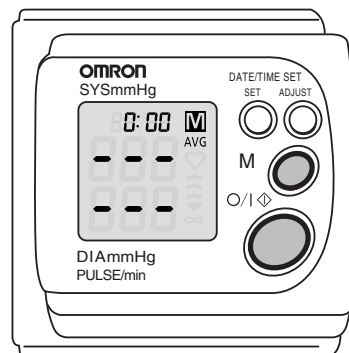

2 Press memory button and simultaneously on/off button to erase memory.



**Caution!** All stored values will be erased!

Press on/off button to turn off power.

### 6 Storage

- Store the OMRON RX3 Plus in the hard case in a dry, closed place with a temperature between -20°C and 60°C.
- Remove the batteries if you not intend to use the OMRON RX3 Plus for 3 months or more.

### 7 Faults: causes and rectifications

	Fault	Cause	Rectification
	Correct reading not possible	Movement, sound vibration, weak pulse	Wait for at least three minutes to repeat measurement
 Display empty	Low voltage	Batteries weak/exhausted	Fit two new identical 1.5V alkaline batteries type AAA
Inexplicable values		Wrong working method	Follow instructions, repeat measurement

## 8 Maintenance and spare parts

### Cleaning instruction

- Use a soft, slightly moistened cloth to clean the OMRON RX3 Plus and the wrist cuff.

**Caution!** Do not use petrol, thinners or similar solvents!

**Caution!** Do not wash the wrist cuff!

- Do not carry out repairs of any kind yourself. If a defect occurs consult your OMRON retail outlet or distributor as mentioned on the packaging.

### Calibration

- It is recommended to have the OMRON RX3 Plus inspected every two years to ensure correct function and accuracy. Consult your OMRON retail outlet or OMRON distributor as mentioned on the packaging.

### Replace batteries

- Remove the battery out of the

battery compartment and insert two new identical 1.5V alkaline batteries type AAA.

### Spare parts

- Due to high company quality standards, OMRON considers the main unit as a non-serviceable part because the need for proper calibration after replacement of high tech components.
- If the cuff needs to be replaced have this done by an authorised expert. Consult your OMRON retailer or OMRON distributor as mentioned on the packaging.

**Attention!** Disposal of batteries and the OMRON RX3 Plus should be carried out in accordance with the national regulations for the disposal of electronic products.

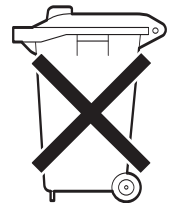

## 9 Technical data

Product name	OMRON Digital Blood Pressure Monitor
Model	RX3 Plus
Display	Digital LCD
Measurement range	Pressure: 0 - 299 mmHg / Pulse: 40 - 180 /minute
Accuracy	Pressure: $\pm 3$ mmHg / Pulse: $\pm 5\%$ of display reading
Inflation	Automatic by electric pump
Deflation	Automatic rapid deflation system
Pressure detection	Electrostatic capacity pressure sensor (capacitive)
Measurement method	Oscillometric method
Memory	21 Measurements
Power supply	2 x 1.5V Alkaline batteries AAA
Battery life	New batteries will last for approx. 400 measurements
Operating temperature /humidity	+10°C to +40°C / 30% to max. 85% relative humidity
Operating environment	Free from excessive vibrations, shocks, magnetic fields, electrical noise, etc.
Storage temperature / humidity	-20°C to +60°C / 10% to max. 95% relative humidity
Weight	Approx. 160 g including batteries
Outer dimensions	Approx. 79 mm (W) x 47 mm (H) x 71 mm (D)
Wrist circumference	Approx. 13.5 cm to 19.5 cm
Accessories	Instruction manual, guarantee card, blood pressure pass, 2 alkaline batteries, storage box
Note	Subject to technical modification without prior notice
 = Type B	
Manufacturer	OMRON HEALTHCARE Co., Ltd. 24, Yamanouchi Yamanoshita-cho, Ukyo-ku, Kyoto, 615-0084 Japan
EU-representative	OMRON HEALTHCARE EUROPE B.V. Kruisweg 577, NL-2132 NA Hoofddorp



This device fulfils the provisions of the EC directive 93/42/EEC (Medical Device Directive). This blood pressure monitor is designed according to the European standard EN1060, Non-invasive sphygmomanometers Part 1: General Requirements and Part 3: Supplementary requirements for electromechanical blood pressure measuring systems.



## 10 General information about blood pressure

### Blood circulation

The blood circulation is responsible for supplying the body with oxygen. Blood pressure is the pressure exerted on the arteries.

The systolic blood pressure value (higher pressure or top value) represents the blood pressure produced by contraction of the heart muscle.

The diastolic blood pressure value (lower pressure or lower value) represents the blood pressure produced by relaxation of the heart muscle.

### Classification of blood pressure

The World Health Organisation (WHO) and the International Society of Hypertension (ISH) developed the blood pressure classification. This classification is based on the blood pressure values measured while sitting on a chair in the outpatient department of a hospital.

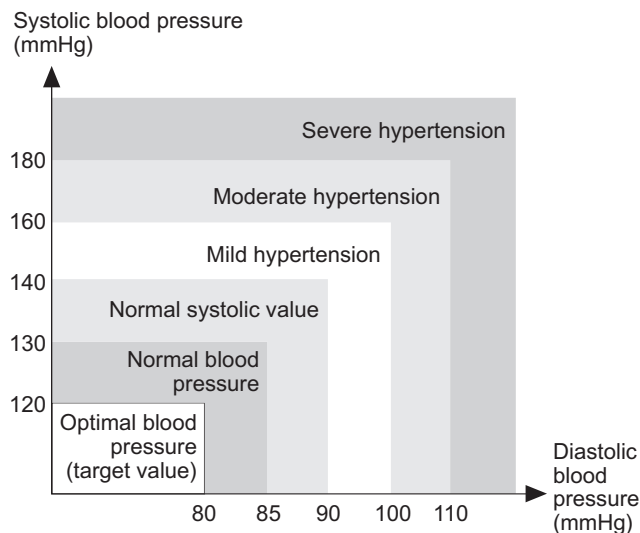

*According to the blood pressure classification by the WHO/ISH.*

### Health and blood pressure

The incidence of hypertension increases with age. In addition, a lack of exercise, excess body fat and high levels of cholesterol (LDL), which sticks to the inside in blood vessels, reduces elasticity of these vessels.

Hypertension accelerates arterial sclerosis which can lead to very serious conditions such as stroke and myocardial infarction. For these reasons it is very important to know whether the blood pressure is within a healthy range. Blood pressure fluctuates from minute to minute, throughout the day. Therefore it is essential to take regular measurements to help you identify an average blood pressure.

### **Symptoms of high blood pressure**

High blood pressure can go unnoticed for a long time, since it does not cause noticeable symptoms. The following are all possible causes of abnormally high blood pressure:

- Overweight
- High cholesterol level
- Smoking
- Excessive alcohol consumption
- Stress and emotional upset
- Excessive consumption of salt
- Lack of physical exercise
- Genetic/hereditary predisposition
- Underlying illnesses, such as kidney disorders or endocrine disturbance

### **Blood pressure measurement**

Measuring your blood pressure daily enables you to recognize high blood pressure at an early stage and obtain medical treatment.

The oscillometric method of measurement determines your blood pressure by measuring the pressure fluctuations caused by the pulse waves.

Since your blood pressure fluctuates within a day (see graphic next page), you should always measure it at the same time each day to ensure that the measurements are genuinely comparable. At the doctor's surgery, nervousness and tension may cause your blood pressure to be higher than in familiar circumstances at home. This is known as "White Coat Hypertension".

## Treatment of high blood pressure

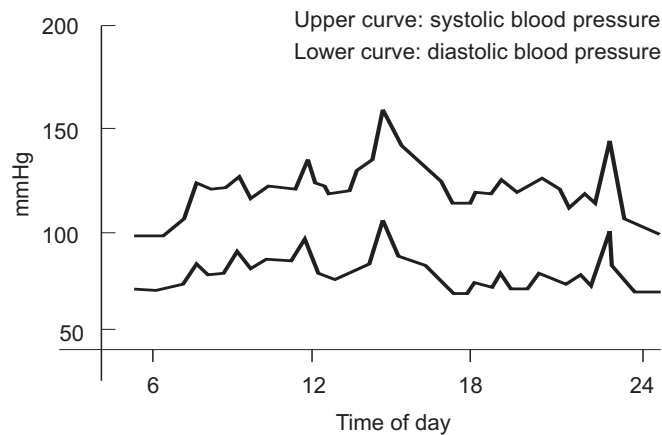

*Example: fluctuation within a day (male, 35 years old)*

If your blood pressure reaches upper values of 140 - 160 mmHg and lower values of 90 - 95 mmHg in repeated measurements over several days, you should consult your doctor for detailed medical examination. You can assist the treatment prescribed by your doctor in the following ways:

- Loose weight and lower your cholesterol level by reducing the calories and fat in your diet. Cut down on animal fats and eat more fruit and vegetables.
- Reduce the consumption of alcohol.
- Reduce the intake of salt: the German League for Combating High Blood Pressure recommends six grams of salt per day (i.e. one teaspoon) on average.
- Stop smoking.
- Take regular exercise.
- Monitor your blood pressure.